



GaAs InGaP HBT MMIC POWER AMPLIFIER, 5 - 6 GHz

Typical Applications

The HMC406MS8G(E) is ideal for:

- WiMAX & WiLAN
- DSRC
- Military & Maritime
- Private Mobile Radio
- UNII & ISM

Features

- Gain: 17 dB
- Saturated Power: +29 dBm
- 38% PAE
- Supply Voltage: +5V
- Power Down Capability
- Low External Part Count

Functional Diagram

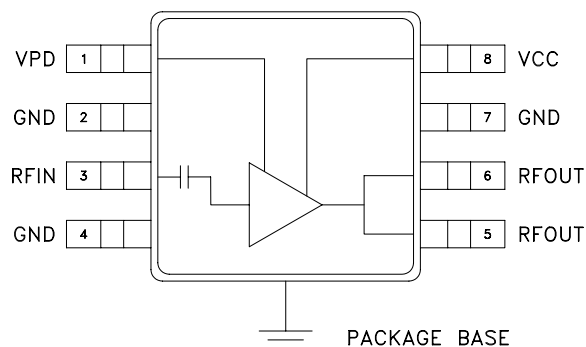

General Description

The HMC406MS8G(E) is a high efficiency GaAs InGaP Heterojunction Bipolar Transistor (HBT) MMIC Power amplifier which operates between 5 and 6 GHz. The amplifier is packaged in a low cost, surface mount 8 leaded package with an exposed base for improved RF and thermal performance. With a minimum of external components, the amplifier provides 17 dB of gain and +29 dBm of saturated power at 38% PAE from a +5V supply voltage. Vpd can be used for full power down or RF output power/current control.

Electrical Specifications, $T_A = +25^\circ\text{C}$, $V_S = 5\text{V}$, $V_{pd} = 5\text{V}$

| Parameter | Min. | Typ. | Max. | Min. | Typ. | Max. | Units |
|--|-------------|------|-------------|-----------|-------------|------|--------|
| Frequency Range | 5 - 6 | | | 5.7 - 5.9 | | | GHz |
| Gain | 13 | 16 | 21 | 14 | 17 | 21 | dB |
| Gain Variation Over Temperature | | 0.03 | 0.04 | | 0.03 | 0.04 | dB/ °C |
| Input Return Loss | | 10 | | | 11 | | dB |
| Output Return Loss | | 8 | | | 9 | | dB |
| Output Power for 1 dB Compression (P1dB) | 21 | 24 | | 24 | 27 | | dBm |
| Saturated Output Power (Psat) | | 27 | | | 29 | | dBm |
| Output Third Order Intercept (IP3) | 34 | 38 | | 34 | 38 | | dBm |
| Noise Figure | | 6.0 | | | 6.0 | | dB |
| Supply Current (Icq) | Vpd = 0V/5V | | 0.002 / 300 | | 0.002 / 300 | | mA |
| Control Current (Ipd) | Vpd = 5V | | 7 | | 7 | | mA |
| Switching Speed | tON, tOFF | | 35 | | 35 | | ns |

HMC406* PRODUCT PAGE QUICK LINKS

Last Content Update: 10/05/2017

COMPARABLE PARTS

View a parametric search of comparable parts.

EVALUATION KITS

- HMC406MS8G Evaluation Board

DOCUMENTATION

Application Notes

- AN-1363: Meeting Biasing Requirements of Externally Biased RF/Microwave Amplifiers with Active Bias Controllers

Data Sheet

- HMC406 Data Sheet

TOOLS AND SIMULATIONS

- HMC406 S-Parameter

REFERENCE MATERIALS

Quality Documentation

- HMC Legacy PCN: MS##, MS##E and MS##G,MS##GE packages - Relocation of pre-existing production equipment to new building
- Package/Assembly Qualification Test Report: MS8G (QTR: 2014-00393)
- PCN: MS, QS, SOT, SOIC Packages - Sn/Pb Plating Vendor Change
- Semiconductor Qualification Test Report: GaAs HBT-B (QTR: 2013-00229)

DESIGN RESOURCES

- HMC406 Material Declaration
- PCN-PDN Information
- Quality And Reliability
- Symbols and Footprints

DISCUSSIONS

View all HMC406 EngineerZone Discussions.

SAMPLE AND BUY

Visit the product page to see pricing options.

TECHNICAL SUPPORT

Submit a technical question or find your regional support number.

DOCUMENT FEEDBACK

Submit feedback for this data sheet.

HMC406* PRODUCT PAGE QUICK LINKS

Last Content Update: 02/23/2017

COMPARABLE PARTS

View a parametric search of comparable parts.

EVALUATION KITS

- HMC406MS8G Evaluation Board

DOCUMENTATION

Application Notes

- AN-1363: Meeting Biasing Requirements of Externally Biased RF/Microwave Amplifiers with Active Bias Controllers

Data Sheet

- HMC406 Data Sheet

TOOLS AND SIMULATIONS

- HMC406 S-Parameter

REFERENCE MATERIALS

Quality Documentation

- HMC Legacy PCN: MS##, MS##E and MS##G,MS##GE packages - Relocation of pre-existing production equipment to new building
- Package/Assembly Qualification Test Report: MS8G (QTR: 2014-00393)
- PCN: MS, QS, SOT, SOIC packages - Sn/Pb plating vendor change
- Semiconductor Qualification Test Report: GaAs HBT-B (QTR: 2013-00229)

DESIGN RESOURCES

- HMC406 Material Declaration
- PCN-PDN Information
- Quality And Reliability
- Symbols and Footprints

DISCUSSIONS

View all HMC406 EngineerZone Discussions.

SAMPLE AND BUY

Visit the product page to see pricing options.

TECHNICAL SUPPORT

Submit a technical question or find your regional support number.

DOCUMENT FEEDBACK

Submit feedback for this data sheet.



**GaAs InGaP HBT MMIC
POWER AMPLIFIER, 5 - 6 GHz**

Broadband Gain & Return Loss

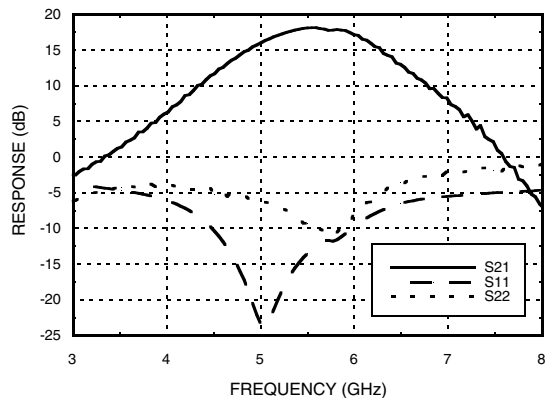

Gain vs. Temperature

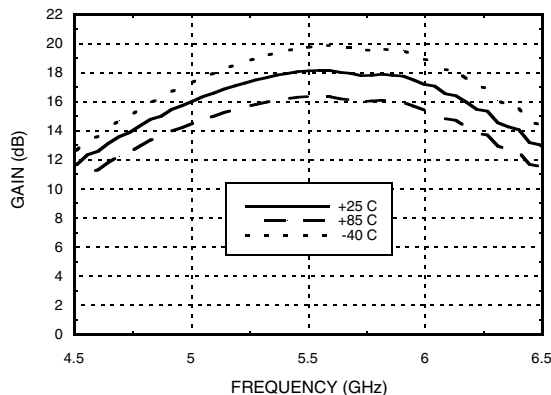

Input Return Loss vs. Temperature

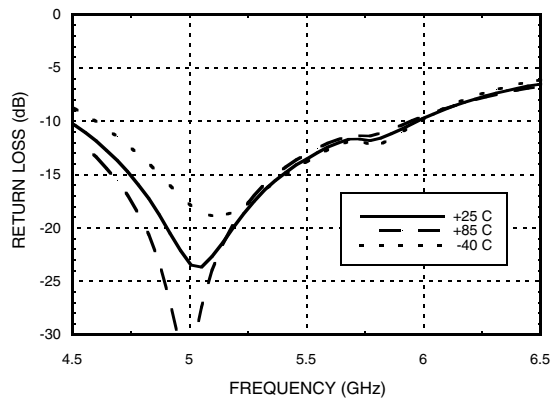

Output Return Loss vs. Temperature

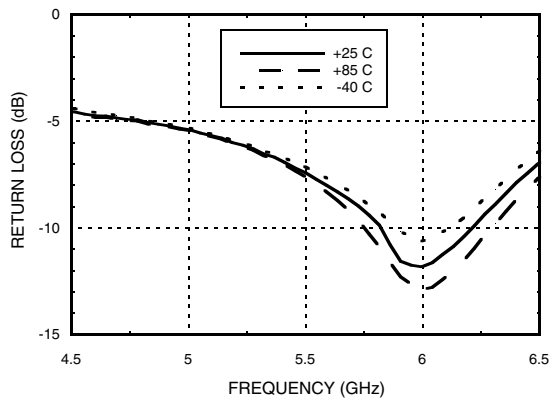

P1dB vs. Temperature

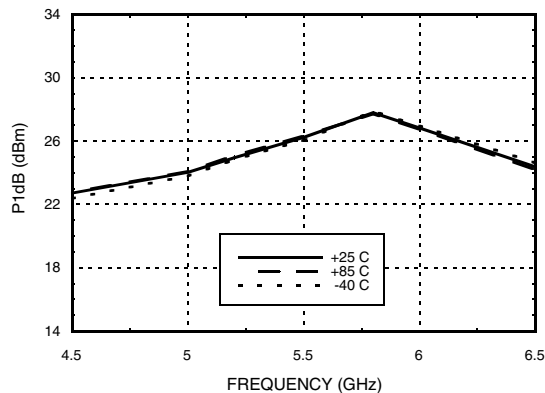

Psat vs. Temperature

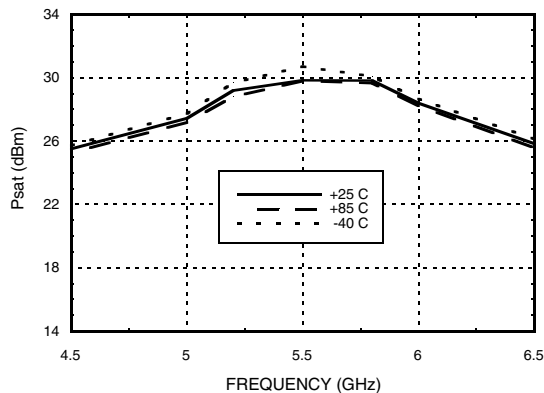



**GaAs InGaP HBT MMIC
POWER AMPLIFIER, 5 - 6 GHz**

Power Compression @ 5.8 GHz

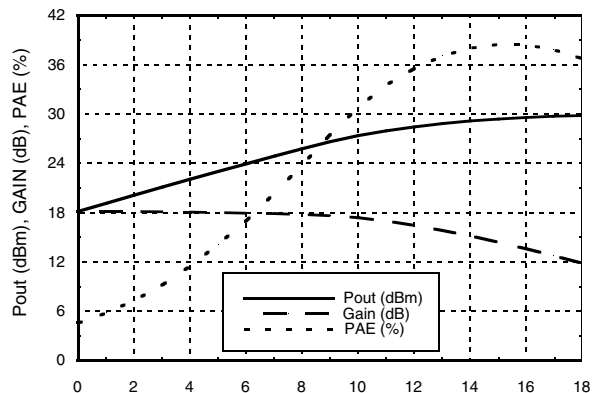

Output IP3 vs. Temperature

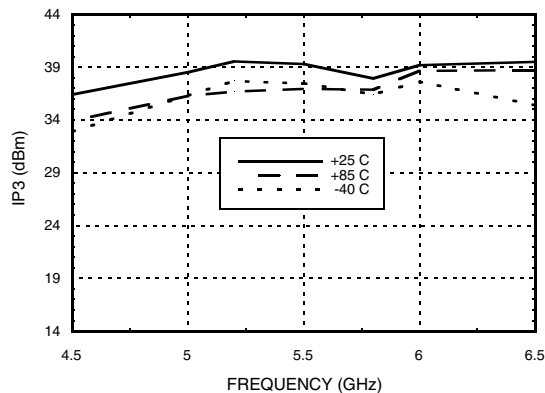

Noise Figure vs. Temperature

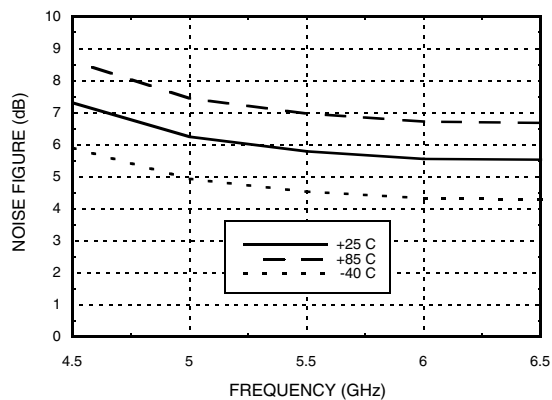

Gain & Power vs. Supply Voltage

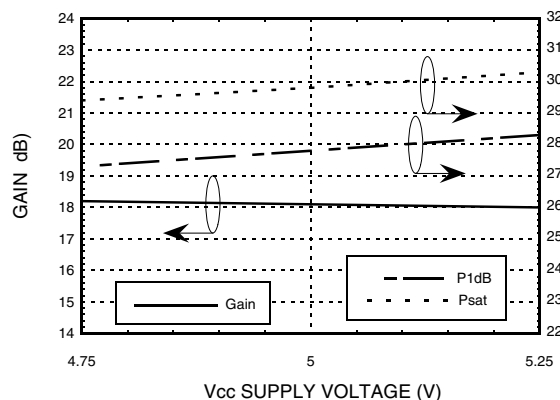

Reverse Isolation vs. Temperature

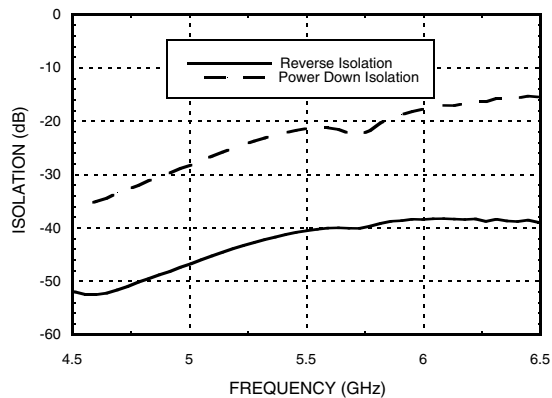

**Gain, Power & Quiescent
Supply Current vs. Vpd @ 5.8 GHz**

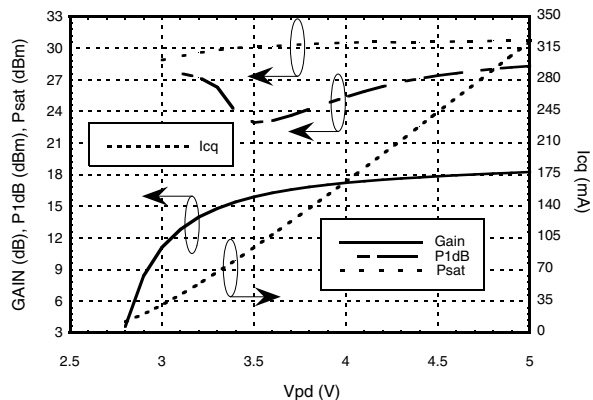

Information furnished by Analog Devices is believed to be accurate and reliable. However, no responsibility is assumed by Analog Devices for its use, nor for any infringements of patents or other rights of third parties that may result from its use. Specifications subject to change without notice. No license is granted by implication or otherwise under any patent or patent rights of Analog Devices. Trademarks and registered trademarks are the property of their respective owners.

For price, delivery, and to place orders: Analog Devices, Inc., One Technology Way, P.O. Box 9106, Norwood, MA 02062-9106 Phone: 781-329-4700 • Order online at www.analog.com Application Support: Phone: 1-800-ANALOG-D



GaAs InGaP HBT MMIC POWER AMPLIFIER, 5 - 6 GHz

Absolute Maximum Ratings

| | |
|---|----------------|
| Collector Bias Voltage (Vcc) | +5.5V |
| Control Voltage (Vpd) | +5.5V |
| RF Input Power (RFIN)(Vs = Vpd = +5V) | +20 dBm |
| Junction Temperature | 150 °C |
| Continuous P _{diss} (T = 85 °C) (derate 32 mW/°C above 85 °C) | 2.1 W |
| Thermal Resistance (junction to ground paddle) | 31 °C/W |
| Storage Temperature | -65 to +150 °C |
| Operating Temperature | -40 to +85° C |



ELECTROSTATIC SENSITIVE DEVICE
OBSERVE HANDLING PRECAUTIONS

Outline Drawing

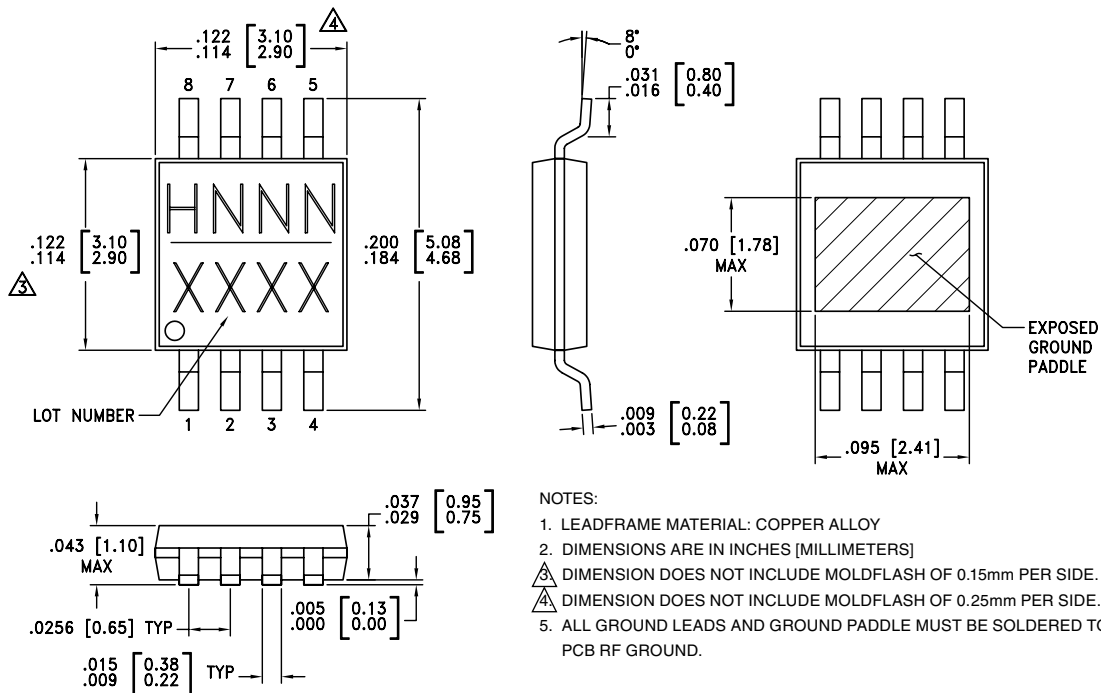

Package Information

| Part Number | Package Body Material | Lead Finish | MSL Rating | Package Marking ^[3] |
|-------------|---|---------------|---------------------|--------------------------------|
| HMC406MS8G | Low Stress Injection Molding Plastic | Sn/Pb Solder | MSL1 ^[1] | H406 XXXX |
| HMC406MS8GE | RoHS-compliant Low Stress Injection Molding Plastic | 100% matte Sn | MSL1 ^[2] | H406 XXXX |

[1] Max peak reflow temperature of 235 °C

[2] Max peak reflow temperature of 260 °C

[3] 4-Digit lot number XXXX



GaAs InGaP HBT MMIC POWER AMPLIFIER, 5 - 6 GHz

Pin Descriptions

| Pin Number | Function | Description | Interface Schematic |
|------------|----------|--|---------------------|
| 1 | Vpd | Power Control Pin. For maximum power, this pin should be connected to 5V. A higher voltage is not recommended. For lower idle current, this voltage can be reduced. | |
| 2, 4, 7 | GND | Ground: Backside of package has exposed metal ground slug that must be connected to ground thru a short path. Vias under the device are required. | |
| 3 | RFIN | This pin is AC coupled and matched to 50 Ohms. | |
| 5, 6 | RFOUT | RF output and bias for the output stage. The power supply for the output device needs to be supplied to these pins. | |
| 8 | Vcc | Power supply voltage for the first amplifier stage. An external bypass capacitor of 330 pF is required. This capacitor should be placed as close to the devices as possible. | |



GaAs InGaP HBT MMIC POWER AMPLIFIER, 5 - 6 GHz

Application Circuit

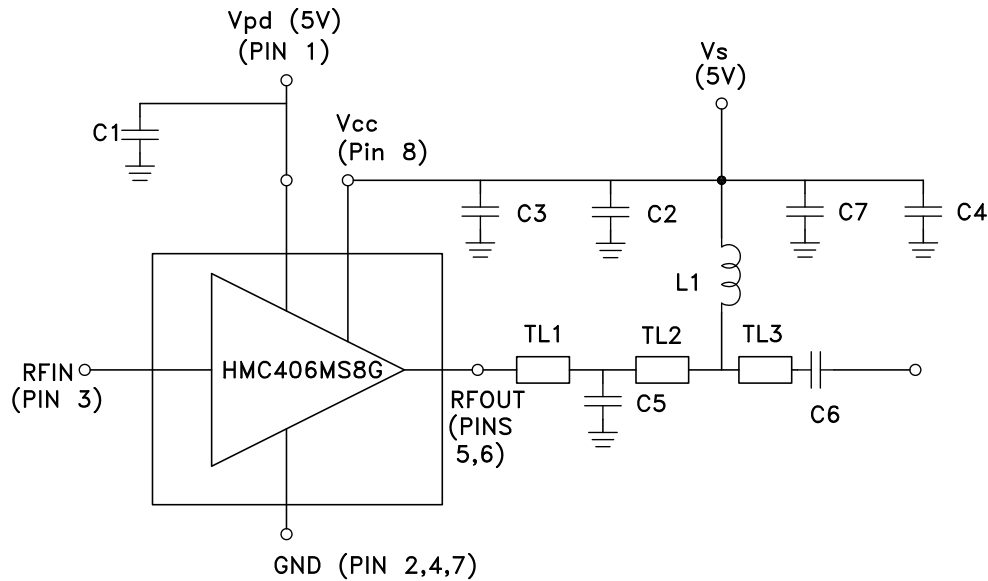

Note 1: C3 should be located < 0.020" from Pin 8 (Vcc)

Note 2: C2 should be located < 0.020" from L1.

| | TL1 | TL2 | TL3 |
|-----------------------------|--|--|--|
| Impedance | 50 ohm | 50 ohm | 50 ohm |
| Physical Length | 0.0443" | 0.2556" | 0.1000" |
| Electrical Length @ 5.5 GHz | 11.3° | 65.2° | 25.5° |
| Measurement | Edge of package pin to center of capacitor C5. | Center of capacitor C5 to center of bias line. | Center of bias line to edge of capacitor C6. |

PCB Material: 10 mil Rogers 4350 or Arlon 25FR



GaAs InGaP HBT MMIC POWER AMPLIFIER, 5 - 6 GHz

Evaluation PCB

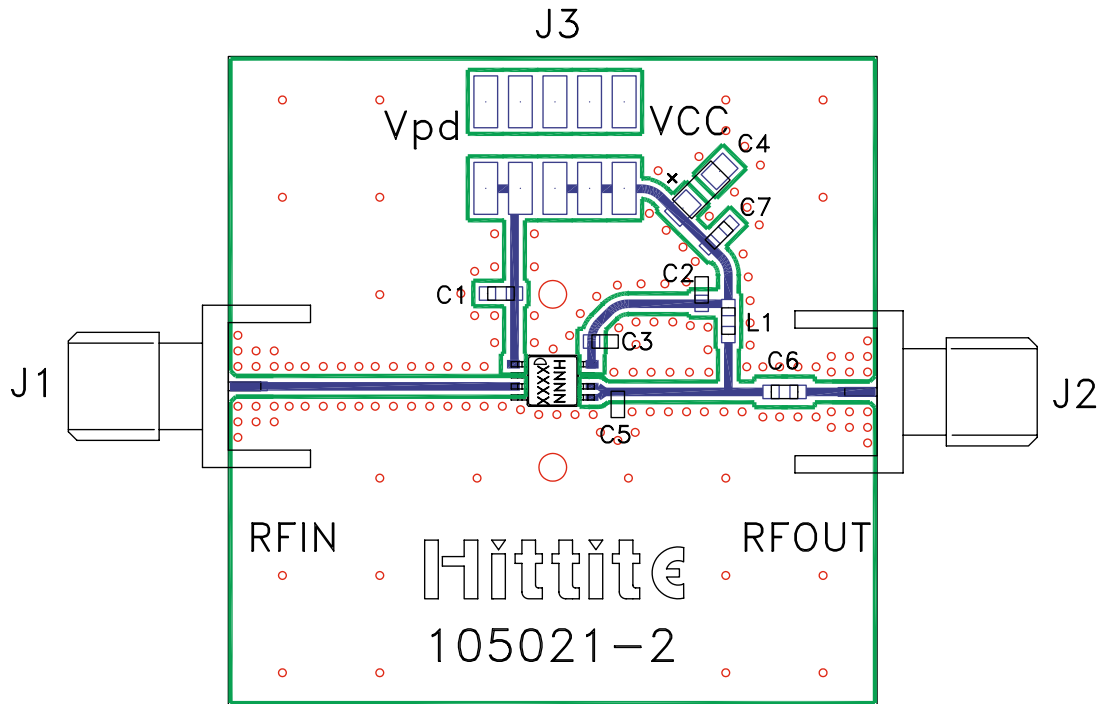

List of Materials for Evaluation PCB 104989 [1]

| Item | Description |
|---------|---------------------------------|
| J1 - J2 | PCB Mount SMA RF Connector |
| J3 | 2mm DC Header |
| C1 - C3 | 330 pF Capacitor, 0603 Pkg. |
| C4 | 2.2 μ F Capacitor, Tantalum |
| C5 | 0.6 pF Capacitor, 0603 Pkg. |
| C6 | 1.6 pF Capacitor, 0603 Pkg. |
| C7 | 100 pF Capacitor, 0603 Pkg. |
| L1 | 3.9 nH Inductor, 0603 Pkg. |
| U1 | HMC406MS8G(E) Amplifier |
| PCB [2] | 105021 Eval Board |

[1] Reference this number when ordering complete evaluation PCB

[2] Circuit Board Material: Roger 4350 or Arlon 25FR

The circuit board used in the application should use RF circuit design techniques. Signal lines should have 50 Ohm impedance while the package ground leads and exposed paddle should be connected directly to the ground plane similar to that shown. A sufficient number of via holes should be used to connect the top and bottom ground planes. The evaluation board should be mounted to an appropriate heat sink. The evaluation circuit board shown is available from Hittite upon request.

**GaAs InGaP HBT MMIC
POWER AMPLIFIER, 5 - 6 GHz****Notes:**